



**Multi-series MPPT charging control
Boost constant current integrated unit
2480 24160 24200
Instruction manual**

Product model	Application scenarios
2480-M	-M Multi-series MPPT charging control boost constant current integrated machine
24160-M-2.4G	
24200-M-2.4G	
2480-G	-G Multi-string MPPT charging control boost constant current integrated unit with induction function (External induction module)
24160-G	
24200-G	
2480-I	-I Multi-string MPPT charging control boost constant current integrated unit with IoT functionality (External communication module)
24160-I	
24200-I	

1. Product Features

- Extremely low dormant current, resulting in greater energy efficiency and convenient long-distance transportation and storage.
- It autonomously adjusts the lighting power based on real-time battery capacity and solar charging capacity, ensuring both brightness and lighting duration, and guaranteeing 365-day-a-year illumination.
- Multiple intelligent power modes are available, automatically adjusting load power according to battery charge.
- High-precision digital boost constant current control algorithm ensures high efficiency and high constant current accuracy.
- Multiple protection functions including LED short circuit/open circuit/power limit protection.
 - Expandable sensing function.
 - Expandable IoT remote communication monitoring function.
 - All-aluminum metal casing, IP67 waterproof rating, suitable for use in various harsh environments.

2. Instructions for use

2.1 MPPT Charging Introduction

MPPT, short for Maximum Power Point Tracking, is an advanced charging method. An MPPT controller can detect the power output of the solar panel in real time and track the highest voltage and current value (VI), enabling the system to charge the battery with maximum efficiency. Compared to traditional PWM controllers, MPPT controllers can utilize the maximum power of the solar panel, thus providing a larger charging current. Generally, MPPT improves energy efficiency by 20%-30% compared to PWM controllers. During MPPT charging, the input voltage and current of the solar panel are adjusted in real time to achieve the maximum input power.

Meanwhile, due to differences in ambient temperature and lighting conditions, the maximum power point often changes. The MPPT controller adjusts its parameters in real time according to different conditions to keep the system near the maximum operating point at all times.

2.2 Dormant and Wake-up:

1. Going to the dormant

A. Press the [\[Exit\]](#) button of the RC1 remote control, the controller shuts down all external control devices and enters the dormant state with extremely low power consumption to avoid the lithium battery feed caused by long-term non-use;

B. Press the [OFF] button of the RC6 remote control, the controller shuts down all external control devices and enters the dormant state with extremely low power consumption to avoid the lithium battery feed caused by long-term non-use;

Note: The dormant function is prohibited for long-term storage or transportation.

2. Wake up from the dormant

A. After the controller is dormant, if the photovoltaic panel is connected, the controller can be awakened to charge when the charging conditions are met during the day, and the load will be automatically turned on at night.



B. After the controller is dormant, if press the [ON] button of the RC6 remote control, you can directly wake up the controller to turn on the light even though the photovoltaic panel is not connected.

The dormant and wake state transitions are as follows:

Controller State Remote	Dormancy	Wake-up	Charge	Discharge	LED indicator status after dormancy
RC1	Hold down the [Exit] button	-	-	-	Extinguish all
RC6	Tap the [OFF] button	-	-	-	Extinguish all
Battery overdischarge	After 10 mins Automatic dormancy	-	-	-	The red indicator blinks every 1 second
-	-	PV charge 10 seconds	It can be charged normally during the day.	It can discharge normally after waking up at night.	-
RC6	-	Tap the [ON] button	It can be charged normally during the day.	After waking up, the light will automatically turn on for 2 seconds to test whether the load is normal; It can be discharged normally at night.	-

2.3 Status indication:

The 1230/1260/1280/12120 controller has three indicator lights

LED Light	Indicative content	State	Function	Remote control system status
	Green indicator light Indicates charging state	Constant light	The photovoltaic panel voltage is greater than the photocontrol voltage	Start the light control
		Extinguish	The photovoltaic panel voltage is less than the photocontrol voltage	Off the light control
		Slow flashing	Be Charging	Be Charging
		Quick flashing	Battery is fully charged	Battery is fully charged
	Red indicator light Indicates battery state	Constant light	Battery is working fine	Normal operation
		Extinguish	The battery is not connected or the remote shuts down	Not running or shutdown status
		Slow flashing	Battery overdischarge	Overdischarge
		Quick flashing	LED load short circuit	Short-Circuit
	Blue indicator light Indicates load state	Constant light	The load is turned on	Discharge
		Extinguish	The load is turned off	Leisure
		Slow flashing	LED load percentage output	Percentage discharge
		Quick flashing	LED load is disconnected	Open-circuit

2.4 Sensing function:

The default delay time for the controller is 20 seconds. The delay time can be changed within the factory as required before mass production.

Controller is divided into two types: human infrared induction (IR) and microwave induction (WB) :

Human infrared sensor is a kind of sensing product made by using the principle of pyroelectric effect, that is, a phenomenon that generates electric charge due to temperature change. The detection range of the infrared sensor probe will be affected by the difference between the temperature of

the human body and the environment, and the higher the environment temperature (the closer to the human body temperature), the less sensitive the sensor.

Microwave inductive sensor is a moving object detector designed by using the principle of the Doppler effect. It detects whether the position of an object has moved by using a non-contact way, and then generates the corresponding switching operation. It has strong anti- RF interference ability, and is not affected by temperature, humidity, light, airflow, dust ,etc.

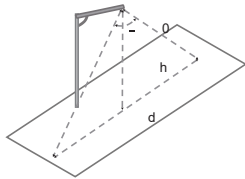

The type of induction	θ (Angle)	H ((Light Pole Height))	D(Induction Width)
IR(Infrared)	60 °	6 ~ 8m	9 ~ 14m
WB(Microwave)	65 °	6 ~ 9m	10 ~ 16m

2.5 IOT functions

IOT function: smart street lights IOT based on IOT technology can achieve intellectualized control of street lamp lighting, thereby improving the efficiency and quality of street lamp lighting. Main advantages:

1. On-demand lighting: realize automatic control of lighting;
2. Remote monitoring: real-time monitoring of the running status of the street lamp, and remote operation of the street lamp switch, remote adjustment of the lighting time;
3. Anomaly monitoring: It can monitor whether the street lamp is abnormal in real time, which is convenient for timely examine and repair.

2.6 Intelligent Power

Intelligent power: When the battery supply is insufficient due to weather or other reasons, in order to ensure the lighting time, the controller starts the smart power reduction to reduce the output power in the preceding period to ensure that there is power in the later time period.

Intelligent power reduction is shown as follows:

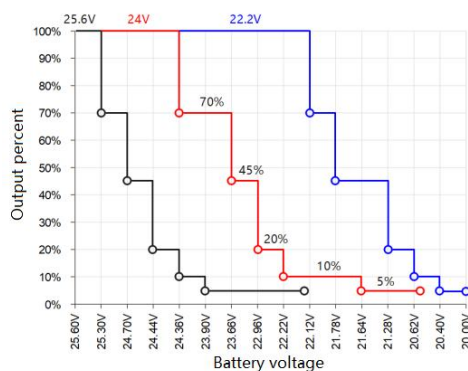

2.7 Size drawing:

2480 size as follows:

Product Size: 85×82×25mm

Installation Size: 76×43.3

Installation Aperture: $\phi 4.0 \times 8.0$

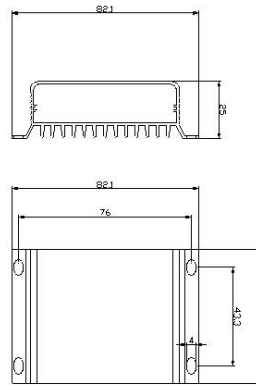

24160 24200 size as follows:

Product Size: 120×99×31mm

Installation Size: 92×50

Installation Aperture: $\phi 4.0 \times 8.0$

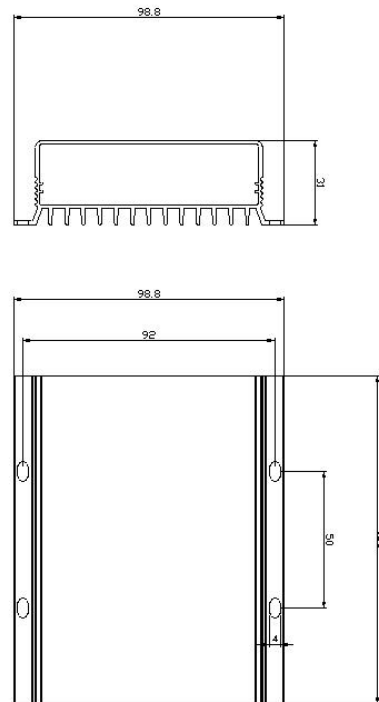

3. Technical parameter

Parameter Name	Parameter Value			Parameter Adjustable	Default Value
Model number	2480	24160	24200		
Controller type	Mppt Charging, Load Boost Constant Current				
System voltage	22.2V/24V/25.6V			√	24V
Static power consumption	≤20mA				
Dormant power consumption	≤8mA				
Load current	0.33-3.30A	0.33-5.94A	0.33-7.26A	√	0.33A
Load voltage	30V~48V				
Maximum load power	80W	160W	200W		
Load conversion efficiency	94%				
Load current accuracy	< 3%				
Intelligent power	Automatic				
Load working period	5 stage time control +1 stage morning light / 4 stage time control +4 stage induction			Support	
Time adjustment amplitude	30Mins				
Power adjustment amplitude	5%				
Maximum charging current	10A	15A	20A		
Solar input voltage	≤ 50V				
Solar input power	360W	540W	720W		
Overvoltage	25.2V/29.2V/29.2V				
Charge return voltage	24.4V/27.6V/27.6V				
Overdischarge voltage	17.10V/21.7V/21.30V				
Light-controlled voltage	Light on: 6.5V, Light off: 9.0V			√	Mid
Light control delay	5S ~ 60S			√	5S
Operating	-35°C ~ +65°C				

temperature				
Class of protection	IP67			
Protection function	Photovoltaic panel reverse connection protection, photovoltaic panel overvoltage protection, lithium battery overcharge and over-discharge protection, lithium battery BMS overvoltage detection protection, load short circuit protection, over-temperature protection, load overcurrent protection, etc.			
Weight (g)	245	530	530	
Controller Size (mm)	85×82×25	120×99×31		

4. Protection Function

◆ Waterproof Protection

Waterproof rating: IP67

◆ lithium battery BMS overcharge detection protection

When the controller detects that the BMS is overcharged, the controller immediately stops charging to prevent the high voltage of the photovoltaic end from being added to both ends of the BMS for a long time, resulting in high voltage damage to the BMS.

◆ High temperature protection

When the ambient temperature is higher than the set value, the controller stops charging and discharging to prevent the risk of damage to the lithium battery due to excessive temperature.

◆ Photovoltaic input overvoltage protection

If the input voltage of the PV panel is too high (reaches 50-55V), the controller automatically cuts off the PV input.

◆ Photovoltaic input reverse protection

When the photovoltaic array polarity is reversed, the controller will not be damaged, and will continue to work normally after correcting the wiring error.

◆ Load limit power protection

When the customer uses the LED lamp power is too large, or the regulating load current is too large, the controller will limit the load power output to less than the rated power to ensure that the controller and the LED load will not be damaged.

- ◆ **Load short-circuit protection**

When a short circuit occurs, the controller immediately cuts off the load output to prevent damage to the controller. After the load short-circuit condition is lifted, the controller will automatically restore the output within 1 minute (if it is short-circuit for a long time, it will automatically restore the output once an hour), or press the remote control test button (CU or mini2) to automatically restore the output after 10S.

- ◆ **Load open circuit protection**

When the LED load light is on normally and the load connection is suddenly disconnected, the controller is not damaged.

- ◆ **Anti-charge protection at night**

Prevent the battery from discharging through the panel at night.

5. Electrical Wiring Diagram

2480 Wiring Diagram:

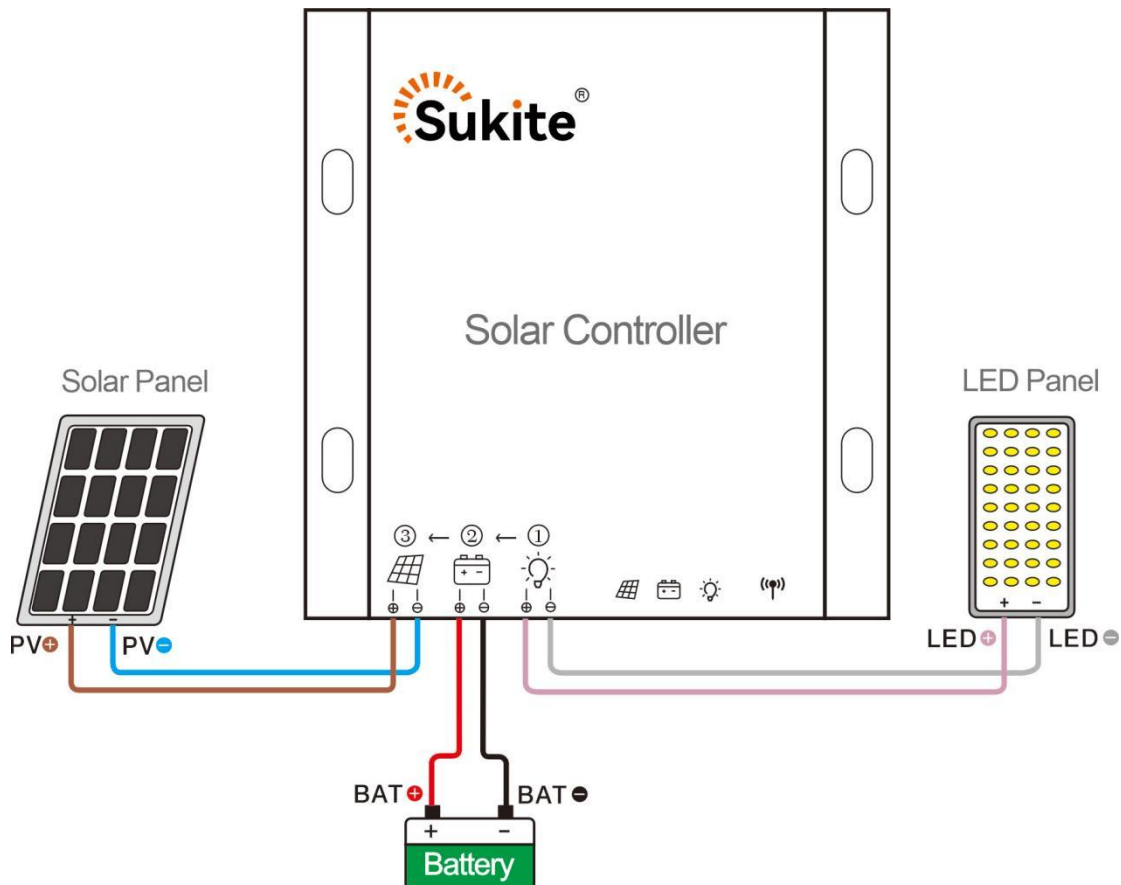

24160 24200 Wiring Diagram:

